

User Manual

IP Phone

IP0022

Version 1.0

Contents Catalogue

1. Introduction.....	2
2. Product Installation.....	4

1. Introduction

Welcome to the user manual for the IP0022. The IP0022 Phone provides all the features and functionalities of a conventional phone and more. Our IP phone guarantees rich function and superb voice quality at an affordable price, which is fully compatible with SIP industry standard, and is able to interoperated with most SIP compliant devices and software on the market. This manual provides the information on basic operations and functions for the phone, which will assist users to quickly learn, and then operate these functions.

CAUTION

Although the adapter of IP Phone is compliant with UL standard, please do not attempt to use other difference power adapter or cut off power supply during configuration or updating phone. Using other power adapters may damage to the IP phone and will void the manufacturer warranty.

1.1 Components

After opening the IP Phone, please verify that all components are available and match the packing list seen below. If you find any contents missing or damaged, contact the place of purchase ASAP.

Components Packing List

Components	Quantity
Main Unit	1 Unit
Handset	1 PCS
Cord	1 PCS
Adapter	1 PCS
RJ45 network cable	1 PCS
User Manual	1 Volume

The following photo shows a broad overview of the IP0022.



1.2 Key Function



There are 34 keys on the phone. Definitions of each is stated are below

Key Button	Mode	Definitions
0 -9	In the dial-up mode In the keypad configure mode	Decimal digit number 0-9 Rapid first press display the digit number 0-9,rapid second press display the English character or others
*	In the dial-up mode In the call hold mode	As one part of phone number when call out Ready to call a third party's number to make three-way (or conference) calling
#	In the keypad configure mode In the dial-up mode	Equal to the dot notation when inputing IP address Ex. 192.168.10.202 As one part of phone number if “#” is the first dialed number, otherwise as the ending symbol to end up dialing
MENU	In the IDLE mode	Enter menu mode and display the tree menu system
Callers	In the IDLE mode	Check the Income/Outgoing/Missed calls record
Three flexible Function Keys	In the IDLE mode or In the keypad configure mode	Select the relevant function on the LCD

Key Button	Mode	Definitions
HOLD	In the keypad configure mode	Temporarily hold the active call
Transfer	In the keypad configure mode	Transfer the active call to another party
REDIAL	In the dial-up mode	Redial the number last dialed
UP/Down	In the IDLE mode	Enter hands-free mode
	In the keypad configure mode	Go back to previous menu item/ Go down to lower menu items
Left/Right	In the keypad configure mode	Continuous thrice press display assigned WAN Port IP, gateway's IP and the phone number registered on public server
	In the idle mode	Choose the item on the menu
MUTE	In the dial-up mode	Mute an active call;
Memory Key 1~4	In the IDLE mode	Show the corresponding recorded phone NO.
Rls	In any mode	Exit to the default idle mode
Directory	In the IDLE mode	Access to phone book.
Hand free	In the IDLE mode	Enable Hand free function
	In the IDLE mode	Adjust the dialing ring volume
	In the hand free mode	Adjust the hand free volume
	In the dial up mode	Adjust the handset volume

2. Product Installation

2.1 Installation

- Insert handset cord into the handset jack and the other end to the left jack of IP Phone
- Insert the power adapter's plug into the phone Power jack and the 2-prong plug end of which is grounded into the power outlet
- Connect one end of the network cable to the WAN port, which is indicated as , the other end of the internet.
- If need to set up small LAN network, find the network cable in the box and connect it between LAN port, which is indicated as  and your PC (PC is not required to set up for making a call)

2.2 Typical Product network connecting Diagrams

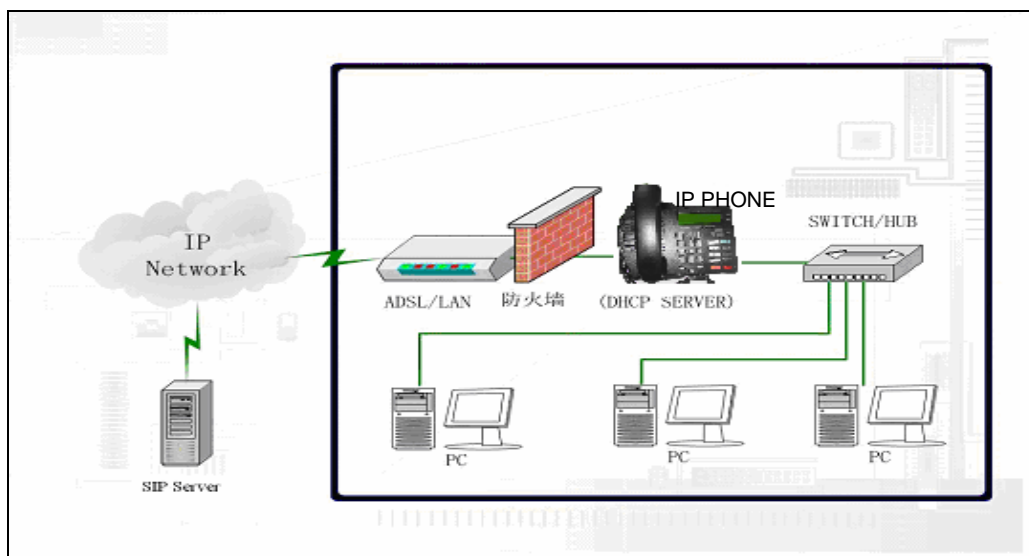
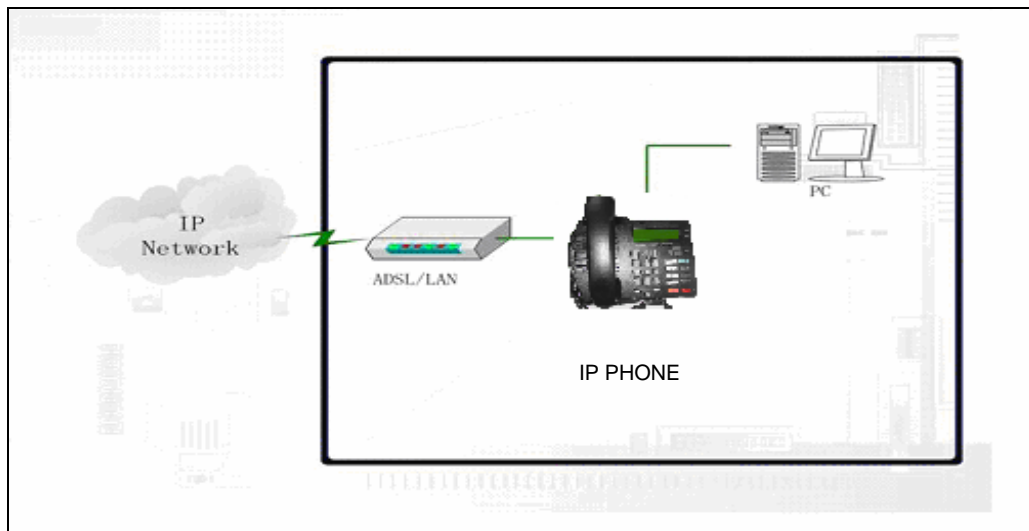

3. IP Phone Configuration

It is easy to config IP phone thru the keypads. First, get the assigned WAN Port IP, gateway's IP and the phone number registered on public server:

Press the Down Key  for three times. It will display the WAN Port IP, gateway's IP and the phone number registered on public server

3.1 Speed Dial Memory Key setting

3.1.1 Set Speed Dial Memory Key

- press **Menu** Key in Idle mode:
- LCD displays **01 Memory Key**
- Select **Choose a Memory Key**
- Choose one from Memory 1 ~ Memory 4
- Enter the phone number you want to speed dial
- Select **Save**
- Finished.

3.1.2 Dial Speed Dial Memory Key



- Press **Memory 1~4** key in idle mode
- Press **Hand free** or pick up the handset

Notice: The key cover can be moved. You can write what you want on the prepared paper in the inner box.



3.2 Screen display setting

- Pressing **Menu** Key in Idle mode
- Press the Down Key .
- The LCD displays **02 Screen Setting**

3.2.1 Letter contrast setting

- Select **Enter**. The LCD displays **01 Contrast**
- Adjust the letter contrast by pressing Left Key  or Right Key 
- Select **Save**
- Finished.

3.2.2 Brightness setting



- Select **Enter**
- Press the Down Key . The LCD displays **02 Brightness**
- Select **Off**, **Low**, **High** of the brightness by pressing Left Key  or Right Key 
- Select **Save**
- Finished.

3.3 Volume Setting



- Pressing **Menu** Key in Idle mode
- Press the Down Key  twice. The LCD displays **03 Volume Setting**

3.3.1 Ringer Volume Setting

- Select **Enter**. The LCD displays **01 Ringer Volume**

- Adjust the ringer volume by pressing Left Key  or Right Key 
- Select **Save**
- Finished.

3.3.2 Call Part Volume

- Select **Enter**. The LCD displays **01 Call Party Volume**
- Adjust the call party volume by pressing Left Key  or Right Key 
- Select **Save**
- Finished.

3.3.3 Greeting Message Setting

- Pressing **Menu** Key in Idle mode
- Press the Down Key  three times. The LCD displays **04 Greeting Message**
- Select **Edit**
- Enter the greeting message with the Number Key and Letter Key (The LCD displays number while pressing Number Key **0** ~ **9** once and displays the Lowercase letter / Capital letter while pressing twice. The ***** stands for full stop or comma. **#** stands for space.
- Select **Save**
- Finished

3.3.4 Language Setting

- Pressing **Menu** Key in Idle mode
- Press the Down Key  four times. The LCD displays **05 Language**





Notice: The phone only supports English at the present. It will support more than one language in the future.

3.4. SIP Setting

- Pressing **Menu** Key in Idle mode
- Press the Down Key  five times. The LCD displays **06 SIP Setting**

3.4.1 SIP server setting

- Select **Enter**. The LCD display **01 SIP 1**
 - SIP 1 setting
 - Select **Enter**. The LCD display **01 SIP 1 Server**
 - Select **Edit**. Enter the IP domain/ IP address.
 - Select **Save**
 - Finished.
 - SIP Number Setting
 - Return to **01 SIP 1**
 - Press the Down Key  once. The LCD displays **02 SIP 1 Number**



- Select **Edit**. Enter the SIP 1 Number
- Select **Save**
- Finished.
- SIP Account Setting
 - Return to **01 SIP 1**
 - Press the Down Key  twice. The LCD displays **03 SIP 1 Account**
 - Select **Edit**. Enter the SIP 1 Account
 - Select **Save**
 - Finished.
- SIP Password Setting
 - Return to **01 SIP 1**
 - Press the Down Key  for three times. The LCD displays **04 SIP 1 Password**
 - Select **Edit** with Flexible Function Key. Enter the SIP 1 Password
 - Select **Save**
 - Finished.
- Register Setting
 - Return to **01 SIP**
 - Press the Down Key  for four times. The LCD displays **04 SIP 1 Register**
 - Press Left Key  or Right Key  to select ON / OFF
 - Select **Save**
 - Finished.



SIP 1 Account Setting finished.

SIP 2 Account Setting is the same as SIP 1 Account Setting



(Notice: You can select the SIP account by pressing **SIP with Flexible Function Key when the phone is registered two SIP account.)**

3.4.2 Network Setting



- Pressing **Menu** Key in Idle mode
- Press the Down Key  for six times. The LCD displays **07 Network Setting**
- Net Mode Setting
 - Select **Enter**. The LCD displays **01 Net Mode**
 - Press Left Key  or Right Key  to select Static / DHCP / PPPoE
 - Select **Save**
 - Finished.
- Static Setting
 - Return to **07 Network Setting**.

- Select **Enter** and go into WAN port network setting.
- Press the Down Key  and go into the Static Setting.
The LCD displays **02 Static Setting**
- Select **Enter** the LCD displays **01 Static IP**
- Select **Edit**. Enter the Static IP.
- Select **Save**
- Finished.
- ◆ Return to the Static IP Setting mode. The LCD displays **02 Static Setting**
- Select **Enter** and press
- Select **Enter**. Press the Down Key  twice. The LCD displays **04 Static DNS**
- Select **Edit**. Enter the gateway IP
- Select **Save**
- Finished.

3.5 PPPoE Setting

- Return to **07 Network Setting**
- Select **Enter** and go into WAN port network setting.
- Press the Down Key  twice. The LCD displays **03 PPPoE Setting**
- Select **Enter**. The LCD displays **01 Account**
- Select **Edit**. Enter the PPPoE account. Please refer to 3.4
- Select **Save**
- Finished.
- ◆ Return to **03 PPPoE Setting**
- Select **Enter**. Press the Down Key . The LCD displays **02 Password**
- Select **Edit**. Enter the PPPoE password.
- Select **Save**
- Finished.

3.6 Ring Type Setting

- Press **Menu** Key in Idle mode
- Press the Up Key . The LCD displays **08 Ring Type**.
- Press Left Key  or Right Key  to select the ring type. (There are 8 default ring types).
- Select **Save**
- Finished.

3.7 Check the Callers Record

You can check the incoming calls, outgoing calls and missed calls by pressing **Callers**

3.8 Voice Recording

Voice record while calling

- Press **Rec**.
- Press **Stop** to stop the record.

Notice: You can make a voice recording for 20 minutes.

Check the voice recording

- Press **Rec**. The LCD displays **Receive Record**
- Select **Enter**

3.9 User Record

- Press **Rec**
- Press the Down Key 
- **enter User Record** → Press **Rec**

Notice: The record can work as User message.

4. Making Call

4.1 Dial PSTN Phone or extension

There are three dialing modes:

- Pick up handset or press [SPEAKER] button, input the phone numbers, IP phone will send out the numbers with the DTMF tones, meanwhile phone numbers are displayed on LCD.
- In the off hook mode or Hands-free mode, Press the REDIAL/SEND button directly to redial the number last called. Once pressed, the last dialed number will be displayed on the LCD with DTMF tones and an outgoing call is sent.
- Make use of Speed dialing mode: Press one number of Memory1~Memory2, →off hook mode/Hands-free mode. An outgoing call is sent.

4.2 Dial IP Phone

Making IP to IP calling is nearly same as dialing general PSTN Phone, there are three ways to set IP phone number and domain

- a) “Peer to Peer” calling mode: direct make calls and no need to set phone number thru proxy server (user could refer to Dial peer setting on web configuration charter).The phone should be operated under following condition (satisfy one option)
 - Both two phones are assigned the public IP address individually
 - Both two phones using private IP address should be on the same LAN.
- b) Dialing the IP number configured by public agency, both two phones should be already registered on the public server.
- c) Dialing the IP number configured by private agency, both two phones should be already registered on the private server and add the dial peer rule for private agency.

4.3 Answering Calls

There are three ways to receive incoming calls:

- Pick up handset to receive incoming calls
- Press the SPEAKER button to receive incoming calls
- Start-up the voice message function to record the incoming calls, afterwards listen to voice messages thru phone audio play
- Operations: Enter REC→RECEIVED→NEW→LIST NO submenu

Note: User can switch from a hands-free call to handset by picking up the handset. To switch from a handset call to a hands-free call, press hands-free button, and then hang up the handset.

5. Troubleshooting

1. The phone can not config WAN or LAN Static IP.

When the phone is in NAT mode(non-bridge)mode, do not config WAN and LAN to the segment.

For example: the LAN IP is 192.168.1.×. please do not config WAN IP to 192.168.1.×.

2. The phone receives busy sound

The phone will auto check the network. When it finds that the phone is not connected to the

network it is using, it will send a busy sound to remind the user. Please check the photo to see if it is connected to the network correctly.

3. I have configed WAN Static IP. But after I confirm pressing Local IP, the IP is unchanged.

Because WAN and LAN are in the same segment. Change LAN IP to another segment

4. I can not logon the phone by Telnet

Possibly both IP Phone and PC(Personal Computer) use the private IP address. For example: the phone uses 192.168.1.179, the PC uses 192.168.10.180. You can try give PC another IP as 192.168.1.××.

5. I can not make phone call after config according to the User Manual.

Please check the network. Logon the phone by telnet, Ping or trace route.

6. Default Factory Setting

- Gain IP address thru DHCP mode on WAN port. Switch to STATIC mode, the static IP address of WAN Port is 192.168.1.176, the IP address of LAN port is 192.168.10.1.Default is to start the DHCP service and NAT function.
- Default telecommunication protocol is to use SIP, SIP port is 5060
- Default HTTP port is 80, Telnet port is 23
- Default ending rule is to end with <#> button
- Default user account is admin and guest, the password of “admin” is admin, the password of “guest” is guest. Since “Admin” and “Guest” account are authorized to modify system configuration (“Guest” account can modify the configuration except SIP info), users should modify the password accordingly after the first entry to ensure system safety.
- Default phone time is to use SNTP protocol to get GMT

7. Appendix

7.1 Maintenance

The following is advice to maintain the IP0022 correctly.



- Keep young children and infants away from the IP Phone and its accessories.
- The IP Phone should be deployed in a clean and dry environment. High temperature, rain water, humidity and liquid contained mineral will erode the electronic components.
- Don't use or store the IP phone in bad environment that will damage the IP phone parts.
- Don't take apart or modify the IP phone. Any operation without formal authorization by manufacturer will damage IP phone.
- Don't throw, hit or shake IP phone, rough treatment with IP phone will damage inner circuits.
- If IP phone, parts or fittings can not work properly, please contact the local distributor appointed by manufacturer.

CAUTION

All operations of our product must abide by the instructions provided by the manufacturer. Any changes or modifications to this product without formal authorization by manufacturer, or operation of IP phone in any way other than the instructions stated on this user manual will void the manufacturer warranty.

7.2 Warranty Policy

Our products have passed through strict quality test before delivery. Manufacturer provides service that requires you to submit the guarantee card and receipt for local distributor's confirmation before reparations are made.

Make sure to read and abide by the warranty policy in order to get our reparation service.

The free reparation only applies to damage caused by manufacturer under conditions of correct operation.

Our company guarantees one year free preparation for complete unit while it will be void manufacturer warranty in following cases.

- Customer damage IP phone due to use, maintenance and improper storage.
- Customer self-repaired IP phone
- No Guarantee Card and valid receipt or other effective purchasing certificate
- Damage due to force or natural hazard

All guarantee information, products function and specification are subject to change without notice.

7.3 Specification

IP Phone Type	IP PHONE
Network Protocol	HTTP、RTP、RTCP、TFTP、TCP、UDP、DHCP、DNS、ARP、ICMP、NTP、PPPoE、NAT
Audio standard	Codec: ITU G.729, G.723 r63/r53,G.711 U/A

	Echo cancellation: Support G.168, and Hands-free can support 96ms Support Jitter Buffer, VAD, CNG Support conference call and voice record DTMF: Support SIP info, DTMF Relay, RFC2833 Call control features: Hotline, Empty calling No. reject service, Black list for reject authenticated call, No disturb, Caller ID
Network port	WAN RJ45 10/100 Base-T: connect to internet LAN RJ45 10/100 Base-T: connect to PC
Phone & keypad	34 button keypad, 1LCD
Adapter/ POE	Input:100-240VAC 50-60Hz Output:+9VDC, 600MA
Dimension(W×H×D)	295×205×75 mm
Weight	1. 5kg
Operating Temperature	0-40°C
Relative Humidity	10-65% (Non-condensing)

We reserve the right to do any changes or make enhancements of this publication without further notice. Thanks for your understanding and continuous support.